



RR Series Power Relays

Key features:

- SPDT through 3PDT, 10A contacts
- Midget power type relays
- Available in pin and blade terminal styles.
- Options include an indicator, check button for test operations and side flange.
- DIN rail, surface and panel mount sockets are available for a wide a variety of mounting applications.



Part Number Selection

Contact	Model	Part Number		Coil Voltage Code (Standard Stock Items in Bold)
		Pin Terminal	Blade Terminal*	
	Standard	—	RR1BA-U <input type="checkbox"/>	AC6V, AC12V, AC24V, AC110V, AC120V , AC240V, DC6V, DC12V, DC24V , DC48V, DC110V
	With Indicator		RR1BA-UL <input type="checkbox"/>	
	With Check Button		RR1BA-UC <input type="checkbox"/>	
	With Indicator and Check Button		RR1BA-ULC <input type="checkbox"/>	
	Side Flange Model		RR1BA-US <input type="checkbox"/>	
	Standard	RR2P-U <input type="checkbox"/>	RR2BA-U <input type="checkbox"/>	
	With Indicator	RR2P-UL <input type="checkbox"/>	RR2BA-UL <input type="checkbox"/>	
	With Check Button	RR2P-UC <input type="checkbox"/>	RR2BA-UC <input type="checkbox"/>	
	With Indicator and Check Button	RR2P-ULC <input type="checkbox"/>	RR2BA-ULC <input type="checkbox"/>	
	Side Flange Model	—	RR2BA-US <input type="checkbox"/>	
	Standard	RR3PA-U <input type="checkbox"/>	RR3B-U <input type="checkbox"/>	
	With Indicator	RR3PA-UL <input type="checkbox"/>	RR3B-UL <input type="checkbox"/>	
	With Check Button	RR3PA-UC <input type="checkbox"/>	RR3B-UC <input type="checkbox"/>	
	With Indicator and Check Button	RR3PA-ULC <input type="checkbox"/>	RR3B-ULC <input type="checkbox"/>	
	Side Flange Model	—	RR3B-US <input type="checkbox"/>	

 *Blade type not TUV tested or CE marked.
Side flange model mounts directly to panel with no socket required.

Ordering Information

When ordering, specify the Part No. and coil voltage code:

(example) **RR3B-U** **AC120V**
Part No. Coil Voltage Code



Sockets

Relays	Standard DIN Rail Mount	Finger-safe DIN Rail Mount	Through Panel Mount
RR2P	SR2P-05 SR2P-06	SR2P-05C	SR2P-51
RR3PA	SR3P-05 SR3P-06	SR3P-05C	SR3P-51
RR1BA RR2BA RR3B	SR3B-05	—	SR3B-51







All DIN rail mount sockets shown above can be mounted using DIN rail BNDN1000.

Hold Down Springs & Clips

Appearance	Description	Relay	For DIN Mount Socket	For Through Panel & PCB Mount Socket
	Pullover Wire Spring	RR2P	SR2B-02F1	SR3P-01F1
		RR3PA	SR3B-02F1	
		RR1BA, RR2BA, RR3B	SR3B-02F1	SR3B-02F1
	Leaf Spring (side latch)	RR2P, RR3PA	SFA-203	–

Accessories

Item	Appearance	Use with	Part No.	Remarks
Aluminum DIN Rail (1 meter length)		All DIN rail sockets	BNDN1000	The BNDN1000 is designed to accommodate DIN mount sockets. Made of durable extruded aluminum, the BNDN1000 measures 0.413 (10.5mm) in height and 1.37 (35mm) in width (DIN standard). Standard length is 39" (1,000mm).
DIN Rail End Stop		DIN rail	BNL5	9.1 mm wide.
Replacement Hold-Down Spring Anchor		Horseshoe clip for sockets SR3B-05, SR2P-06, SR3P-06	Y778-011	For use on DIN rail mount socket when using pullover wire hold down spring. 2 pieces included with each socket.
		Chair clip for sockets SR2P-05(C), SR3P-05(C)	Y703-102	

Specifications

Contact Material	Silver		
Contact Resistance ¹	30 mΩ maximum		
Minimum Applicable Load	1V DC, 10 mA		
Operating Time ²	25 ms maximum		
Release Time ²	25 ms maximum		
Power Consumption (approx.)	AC: 3 VA (50 Hz), 2.5 VA (60 Hz) DC: 1.5W		
Insulation Resistance	100 MΩ minimum (500V DC megger)		
Dielectric Strength	Pin Terminal	Between live and dead parts:	1500V AC, 1 minute
		Between contact and coil:	1500V AC, 1 minute
		Between contacts of different poles:	1500V AC, 1 minute
		Between contacts of the same pole:	1000V AC, 1 minute
	Blade Terminal	Between live and dead parts:	2000V AC, 1 minute
		Between contact and coil:	2000V AC, 1 minute
		Between contacts of different poles:	2000V AC, 1 minute
		Between contacts of the same pole:	1000V AC, 1 minute
Operating Frequency	Electrical:	1800 operations/h maximum	
	Mechanical:	18,000 operations/h maximum	
Vibration Resistance	Damage limits:	10 to 55 Hz, amplitude 0.5 mm	
	Operating extremes:	10 to 55 Hz, amplitude 0.5 mm	
Shock Resistance	Damage limits:	1000 m/s ² (100g)	
	Operating extremes:	100 m/s ² (10G)	
Mechanical Life	10,000,000 operations		
Electrical Life	200,000 operations (220V AC, 5A)		
Operating Temperature ³	-25 to +40°C (no freezing)		
Operating Humidity	5 to 85% RH (no condensation)		
Weight (approx.) (Standard type)	RR2P: 90g, RR3PA: 96g, RR1BA/RR2BA/RR3B: 82g		



1. Measured using 5V DC, 1A voltage drop method
2. Measured at the rated voltage (at 20°C), excluding contact bouncing
3. For use under different temperature conditions, refer to Continuous Load Current vs. Operating Temperature Curve.

Coil Ratings

Rated Voltage (V)	Rated Current (mA) ±15% (at 20°C)		Coil Resistance (Ω) ±10% (at 20°C)	Operating Characteristics (values at 20°C)		
	50 Hz	60 Hz		Maximum Continuous Applied Voltage	Pickup Voltage	Dropout Voltage
AC (50/60 Hz)	6	490	420	110%	80% maximum	30% minimum
	12	245	210			
	24	121	105			
	110	27	23			
	120	24	20.5			
	240	12.1	10.5			
DC	6	240		110%	80% maximum	10% minimum
	12	120				
	24	60				
	48	30				
	110	13				

Contact Ratings

Maximum Contact Capacity					
Continuous Current	Allowable Contact Power		Rated Load		
	Resistive Load	Inductive Load	Voltage (V)	Res. Load	Ind. Load
			10A	1650VA AC 300W DC	1100VA AC 150W DC



Note: Inductive load for the rated load — $\cos \phi = 0.3$, L/R = 7 ms

TÜV Ratings

Voltage	
240V AC	10A
30V DC	10A



AC: $\cos \phi = 1.0$, DC: L/R = 0 ms

UL Ratings

Voltage	Resistive	General use	Horse Power Rating
240V AC	10A	7A	1/3 HP
120V AC	10A	7.5A	1/4 HP
30V DC	10A	7A	—

CSA Ratings

Voltage	Resistive	General use
240V AC	10A	7A
120V AC	10A	7.5A
100V DC	—	0.5A
30V DC	10A	7.5A

Socket Specifications

	Relays	Terminal	Electrical Rating	Wire Size	Torque
DIN Rail Sockets	SR2P-05	M3 screw with captive wire clamp	300V, 10A	Maximum 2 - #12 AWG	9 - 11.5in•lbs
	SR2P-05C	M3 screw with captive wire clamp, fingersafe	300V, 10A	Maximum 2 - #12 AWG	9 - 11.5in•lbs
	SR2P-06	M3 screw with captive wire clamp	300V, 10A	Maximum 2 - #12 AWG	9 - 11.5in•lbs
	SR3P-05	M3 screw with captive wire clamp	300V, 10A	Maximum 2 - #12 AWG	9 - 11.5in•lbs
	SR3P-05C	M3 screw with captive wire clamp, fingersafe	300V, 10A	Maximum 2 - #12 AWG	9 - 11.5in•lbs
	SR3P-06	M3 screw with captive wire clamp	300V, 10A	Maximum 2 - #12 AWG	9 - 11.5in•lbs
	SR3B-05	M3 screw with captive wire clamp	300V, 15A (10A)* (*CSA rating)	Maximum 2 - #12 AWG	9 - 11.5in•lbs
Through Panel Mount Sockets	SR2P-51	Solder	300V, 10A	—	—
	SR3P-51	Solder	300V, 10A	—	—
	SR3B-51	Solder	300V, 10A	—	—

Characteristics (Reference Data)

Electrical Life Curves

AC Load

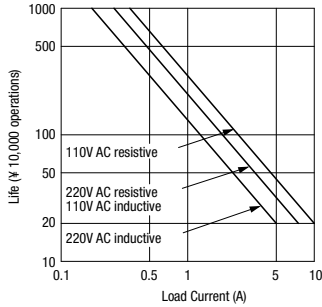

DC Load

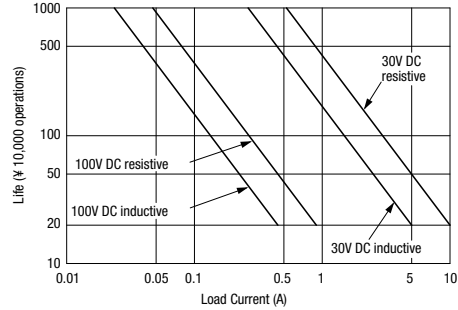

Maximum Switching Capacity

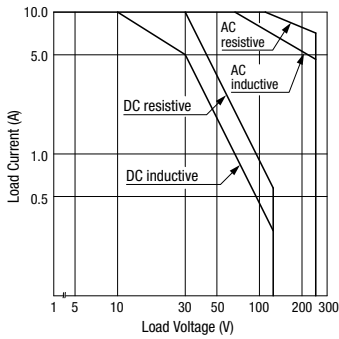

Continuous Load Current vs. Operating Temperature Curve (Standard Type, With Check Button, and Side Flange Type)

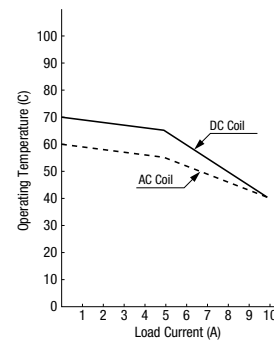

Internal Connection (View from Bottom) Standard Type

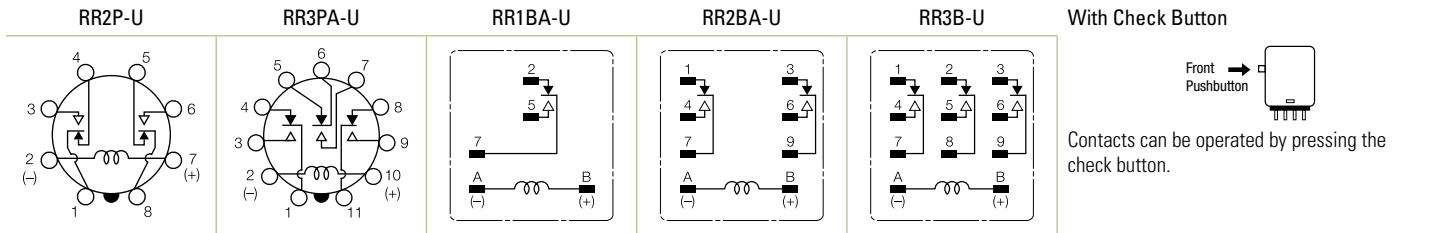

With Indicator (-UL type)

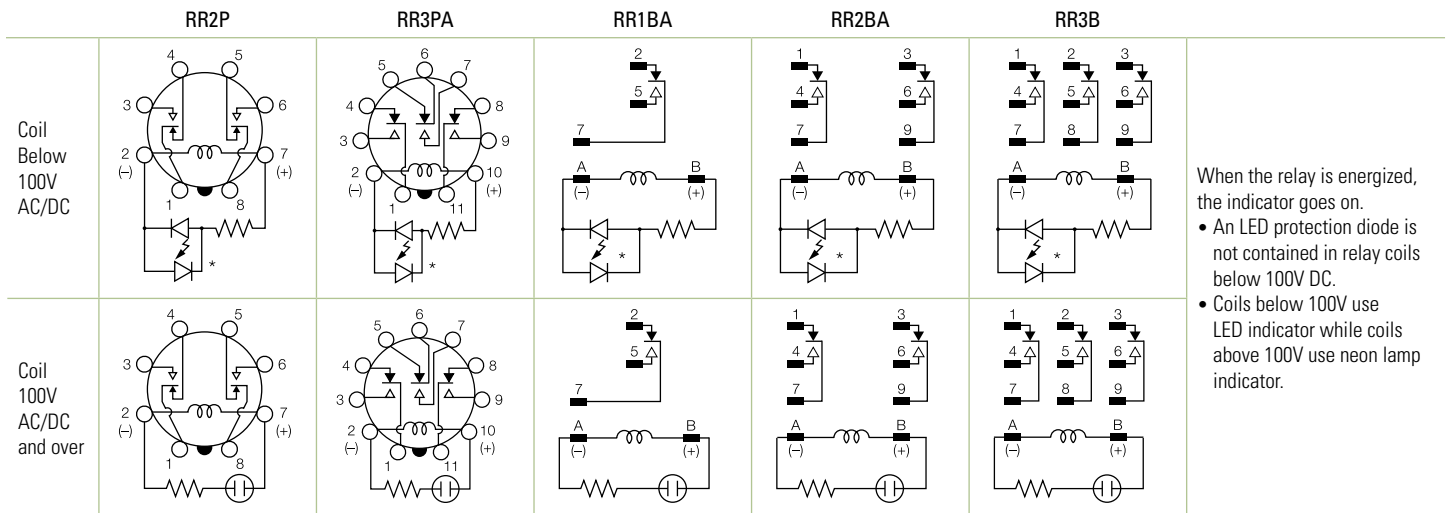

Dimensions (mm)

RR2P-U/RR2P-UL

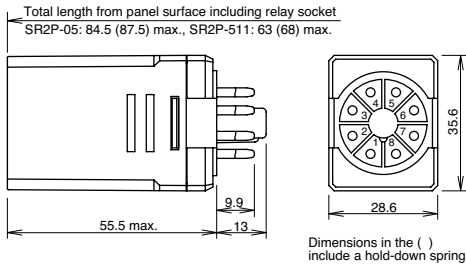

RR3PA-U/RR3PA-UL

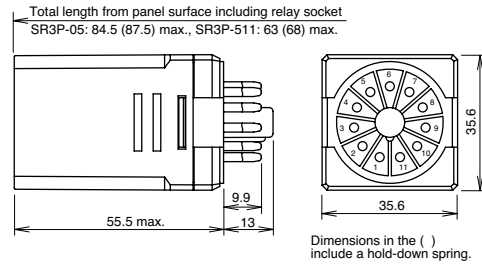

RR1BA-U/RR2BA-UL/RR2BA-U
RR2BA-UL/RR3B-U/RR3B-UL

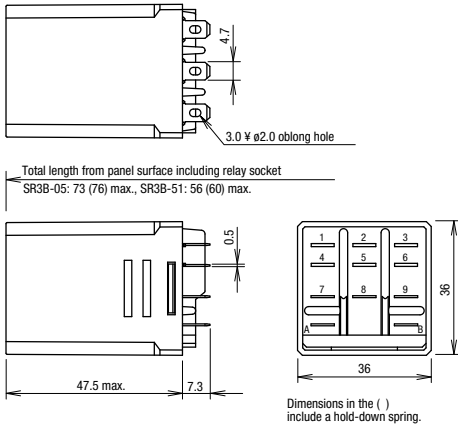

RR1BA-US/RR2BA-US/RR3B-US

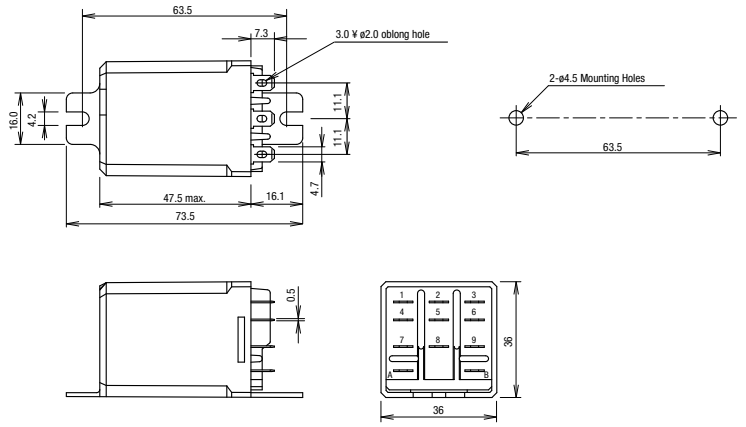

Standard DIN Rail Mount Sockets

SR2P-05

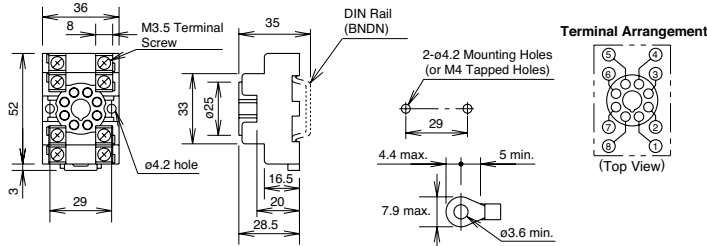

SR2P-06

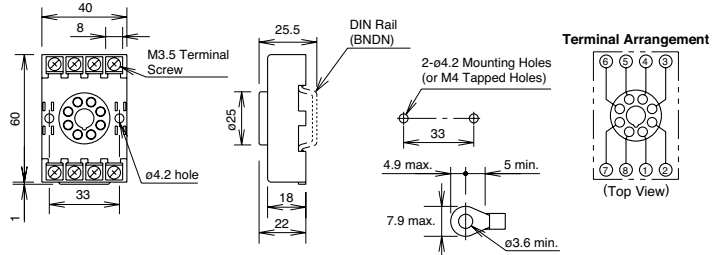

SR3P-05

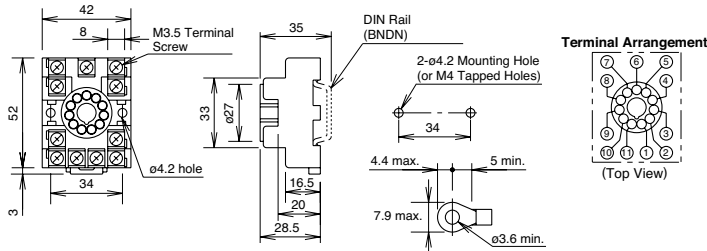

SR3P-06

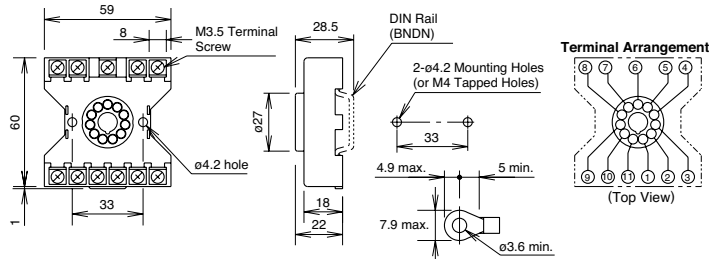

Standard DIN Rail Mount Sockets

SR3B-05

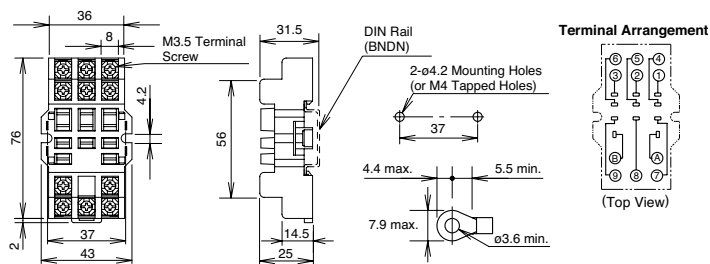

Finger-safe DIN Rail Mount Sockets

SR2P-05C

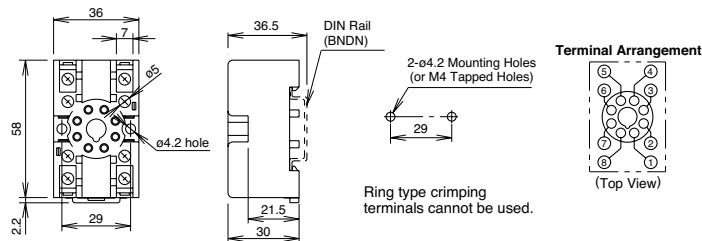

SR3P-05C

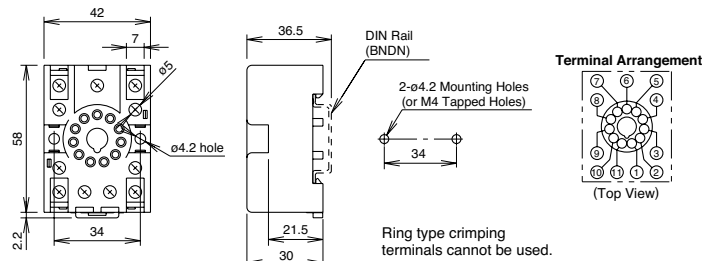

Through Panel Mount Socket

SR2P-51

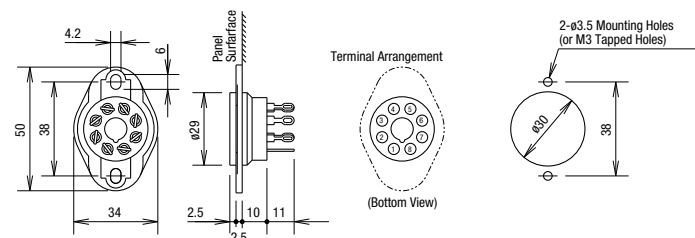

SR3P-51

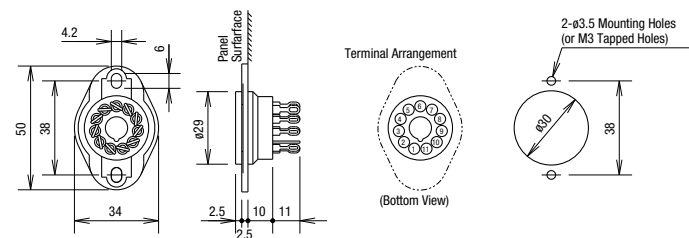

SR3B-51

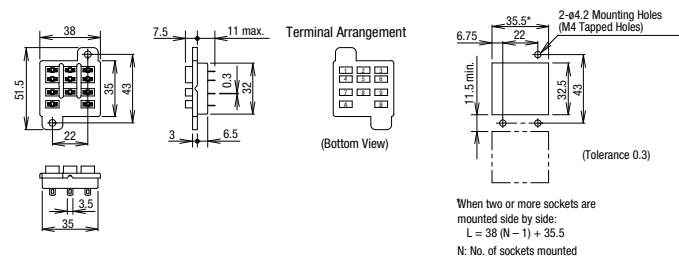

Switches & Pilot Lights

Signaling Lights

Relays & Sockets

Timers

Contactors

Terminal Blocks

Circuit Breakers

Operating Instructions

Driving Circuit for Relays

- To ensure correct relay operation, apply rated voltage to the relay coil.
- Input voltage for the DC coil:
A complete DC voltage is best for the coil power to make sure of stable relay operation. When using a power supply containing a ripple voltage, suppress the ripple factor within 5%. When power is supplied through a rectification circuit, the relay operating characteristics, such as pickup voltage and dropout voltage, depend on the ripple factor. Connect a smoothing capacitor for better operating characteristics as shown below.

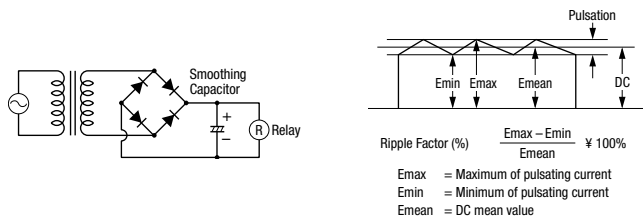

- Leakage current while relay is off:
When driving an element at the same time as the relay operation, special consideration is needed for the circuit design. As shown in the incorrect circuit below, leakage current (I_0) flows through the relay coil while the relay is off. Leakage current causes coil release failure or adversely affects the vibration resistance and shock resistance. Design a circuit as shown in the correct example.

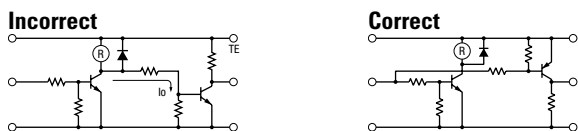

- Surge suppression for transistor driving circuits:
When the relay coil is turned off, a high-voltage pulse is generated, causing a transistor to deteriorate and sometimes to break. Be sure to connect a diode to suppress the back electromotive force. Then, the coil release time becomes slightly longer. To shorten the coil release time, connect a Zener diode between the collector and emitter of the transistor. Select a Zener diode with a Zener voltage slightly higher than the power voltage.

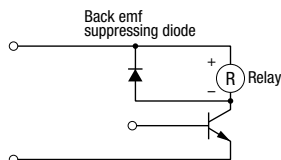

Protection for Relay Contacts

- The contact ratings show maximum values. Make sure that these values are not exceeded. When an inrush current flows through the load, the contact may become welded. If this is the case, connect a contact protection circuit, such as a current limiting resistor.
- Contact protection circuit:
When switching an inductive load, arcing causes carbides to form on the contacts, resulting in increased contact resistance. In consideration of contact reliability, contact life, and noise suppression, use of a surge absorbing circuit is recommended. Note that the release time of the load becomes slightly longer. Check the operation using the actual load. Incorrect use of a contact protection circuit will adversely affect switching characteristics. Four typical examples of contact protection circuits are shown in the following table:

RC	<p> <ul style="list-style-type: none"> R: Resistor of approximately the same resistance value as the load C: 0.1 to 1 μF </p>
Diode	<p> This protection circuit can be used for DC load power circuits. Use a diode with the following ratings. Reverse withstand voltage: Power voltage of the load circuit x 10 Forward current: More than the load current </p>
Varistor	<p> This protection circuit can be used for both AC and DC load power circuits. For a best result, when using a power voltage of 24 to 48V AC/DC, connect a varistor across the load. When using a power voltage of 100 to 240V AC/DC, connect a varistor across the contacts. </p>

- Do not use a contact protection circuit as shown below:

	<p>This protection circuit is very effective in arc suppression when opening the contacts. But, the capacitor is charged while the contacts are opened. When the contacts are closed, the capacitor is discharged through the contacts, increasing the possibility of contact welding.</p>
	<p>This protection circuit is very effective in arc suppression when opening the contacts. But, when the contacts are closed, a current flows to charge the capacitor, causing contact welding.</p>

Generally, switching a DC inductive load is more difficult than switching a DC resistive load. Using an appropriate arc suppressor, however, will improve the switching characteristics of a DC inductive load.

Soldering

- When soldering the relay terminals, use a soldering iron of 30 to 60W, and quickly complete soldering (within approximately 3 seconds).
- Use a non-corrosive rosin flux.

Operating Instructions con't

Other Precautions

1. General notice:

To maintain the initial characteristics, do not drop or shock the relay.

The relay cover cannot be removed from the base during normal operation. To maintain the initial characteristics, do not remove the relay cover.

Use the relay in environments free from condensation, dust, sulfur dioxide (SO₂), and hydrogen sulfide (H₂S).

Make sure that the coil voltage does not exceed applicable coil voltage range.

2. UL and CSA ratings may differ from product rated values determined by IDEC.

3. Do not use relays in the vicinity of strong magnetic field, as this may affect relay operation.

Safety Precautions

- Turn off the power to the relay before starting installation, removal, wiring, maintenance, and inspection of the relays. Failure to turn power off may cause electrical shock or fire hazard.
- Observe specifications and rated values, otherwise electrical shock or fire hazard may be caused.
- Use wires of the proper size to meet voltage and current requirements. Tighten the terminal screws on the relay socket to the proper tightening torque.
- Surge absorbing elements on AC relays with RC or DC relays with diode are provided to absorb the back electromotive force generated by the coil. When the relay is subject to an excessive external surge voltage, the surge absorbing element may be damaged. Add another surge absorbing provision to the relay to prevent damage.

Precautions for the RU Relays

- Before operating the latching lever of the RU relay, turn off the power to the RU relay. After checking the circuit, return the latching lever to the original position.
- Do not use the latching lever as a switch. The durability of the latching lever is a minimum of 100 operations.
- When using DC loads on 4PDT relays, apply a positive voltage to terminals of neighboring poles and a negative voltage to the other terminals of neighboring poles to prevent the possibility of short circuits.
- DC relays with a diode have a polarity in the coil terminals. Apply the DC voltage to the correct terminals.